

PLEASE CHECK WWW.MOLEX.COM FOR LATEST PART INFORMATION

Part Number: [0395354006](#)
Status: **Active**
Description: 5.08mm (.200") Pitch Eurostyle™ Vertical PCB Header, with Threaded Retention Inserts, Surface Mount Compatible, 6 Circuits

Documents:

[3D Model](#) [Product Specification PS-39500-001 \(PDF\)](#)
[Drawing \(PDF\)](#) [RoHS Certificate of Compliance \(PDF\)](#)

General

Product Family	Terminal Blocks
Series	39535
Application	Wire-to-Board
Component Type	PCB Header
Product Literature Order No	USA-355
Product Name	ESE, Eurostyle™ Pluggable
Type	Euro Block

Physical

Circuits (Loaded)	6
Entry Angle	N/A
Lock to Mating Part	Yes
Number of Rows	1
Orientation	Vertical
PC Tail Length (in)	0.200 In
PC Tail Length (mm)	5.08 mm
PCB Thickness Recommended (in)	0.125 In
PCB Thickness Recommended (mm)	3.20 mm
Panel Mount	No
Pitch - Mating Interface (in)	0.200 In
Pitch - Mating Interface (mm)	5.08 mm
Polarized to Mating Part	Yes
Shrouded	Closed Ends
Stackable	No
Surface Mount Compatible (SMC)	Yes
Temperature Range - Operating	-40°C to +140°C
Wire Size AWG	N/A

Electrical

Current - Maximum per Contact	15A
Voltage - Maximum	300V

Material Info

Reference - Drawing Numbers

Product Specification	PS-39500-001
Sales Drawing	SD-39501-002, SD-39535-001

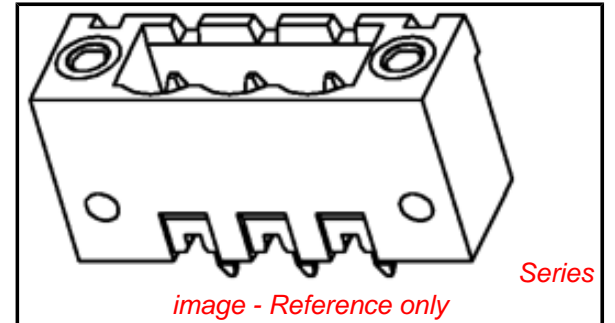

EU RoHS

**ELV and RoHS
Compliant**

REACH SVHC

Not Reviewed

Halogen-Free

Status

Not Reviewed

China RoHS



**Need more information on product
environmental compliance?**

Email productcompliance@molex.com
 For a multiple part number RoHS Certificate of Compliance, [click here](#)

Please visit the [Contact Us](#) section for any non-product compliance questions.

Search Parts in this Series

[39535Series](#)

Mates With

Most 5.08mm (.200") Pitch Industry Standard Plugs, [39534](#) Horizontal Plug with Retention Screws, [39537](#) Vertical Plug with Retention Screws

3950X SERIES
3.50mm HEADERS

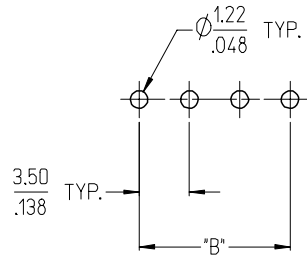

3952X & 3954X SERIES
5.00mm HEADERS
5.00mm 10 AMP FIXED

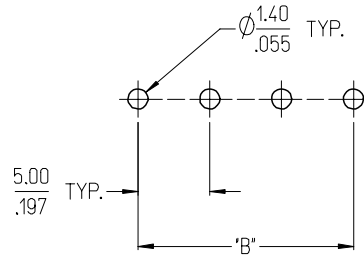

3953X SERIES
5.08mm HEADERS

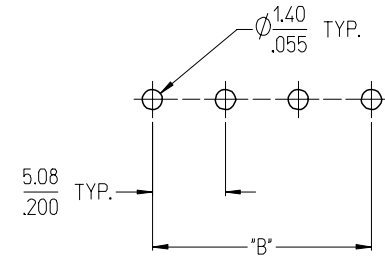

3951X SERIES
3.81mm HEADERS

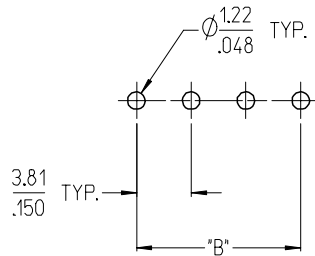

3954X SERIES
5.00mm 15 AMP FIXED

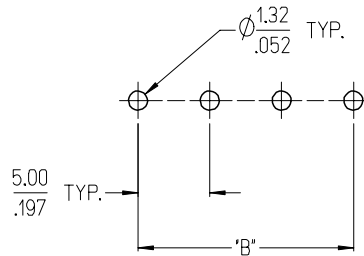

3954X SERIES
5.08mm 15 AMP FIXED

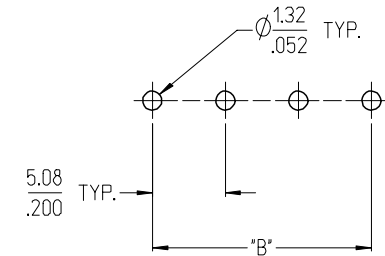

NOTES:

- REFER TO INDIVIDUAL PRODUCT SALES DRAWINGS FOR "B" DIMENSION.
- DOES NOT APPLY TO DUAL LEVEL HEADERS, SERIES 39528 AND 39538.
- TYP. = TYPICAL.

INITIAL RELEASE
EC NO: ETC2007-0096
DRW: CLYORK 2006/10/02
CHKD: JMACNEIL 2006/10/04
APPR: JMACNEIL 2006/10/04

QUALITY SYMBOLS
 = 0
 = 0
 DESCRIPTION
 REV

GENERAL TOLERANCES (UNLESS SPECIFIED)	
	MM/IN
4 PLACES	± .005 / ± .005
3 PLACES	± .005 / ± .005
2 PLACES	± 0.13 / ± .01
1 PLACE	± 0.3 / ± .01
ANGULAR ± 2 °	
DRAFT WHERE APPLICABLE MUST REMAIN WITHIN DIMENSIONS	

DIMENSION STYLE	
MM/IN	
DRAWN BY	DATE
C. YORK	2006/08/25
CHECKED BY	DATE
J. MACNEIL	2006/08/25
APPROVED BY	DATE
J. MACNEIL	2006/08/25
MATERIAL NO.	
--	

SCALE	DESIGN UNITS	THIRD ANGLE PROJECTION
3:1	INCH	
TITLE		
RECOMMENDED PCB LAYOUT FOR ESE TERMINAL BLOCKS		
MOLEX INCORPORATED		
DOCUMENT NO.	SHEET NO.	
SD-39501-002	1 OF 1	
THIS DRAWING CONTAINS INFORMATION THAT IS PROPRIETARY TO MOLEX INCORPORATED AND SHOULD NOT BE USED WITHOUT WRITTEN PERMISSION		

10 9 8 7 6 5 4 3 2 1

F

E

D

C

B

A

F

E

D

C

B

A

SPECIFICATIONS:

1. Material:

- (1). Body: PA46
 - (2). Pin: Brass
 - (3). Threaded insert: Brass
2. Wire range: N/A
 3. Electrical rating: 300V, 15A.
 4. Wire strip length: N/A
 5. Operating temperature: -40C to +140C.
 6. Max torque: N/A
 7. Insulation resistance: DC 500V, 500M.
 8. Dielectric withstand: AC 2500V for 1 minute.
 9. Breakdown voltage: 4000V.
 10. $A = (B + 15.24\text{mm})$
 11. $B = (N - 1) \times P$
 13. $C = (B + 10.16\text{mm})$
 12. P (PITCH) = 5.08mm (.200").
 13. N = Number of positions available 2 through 24.

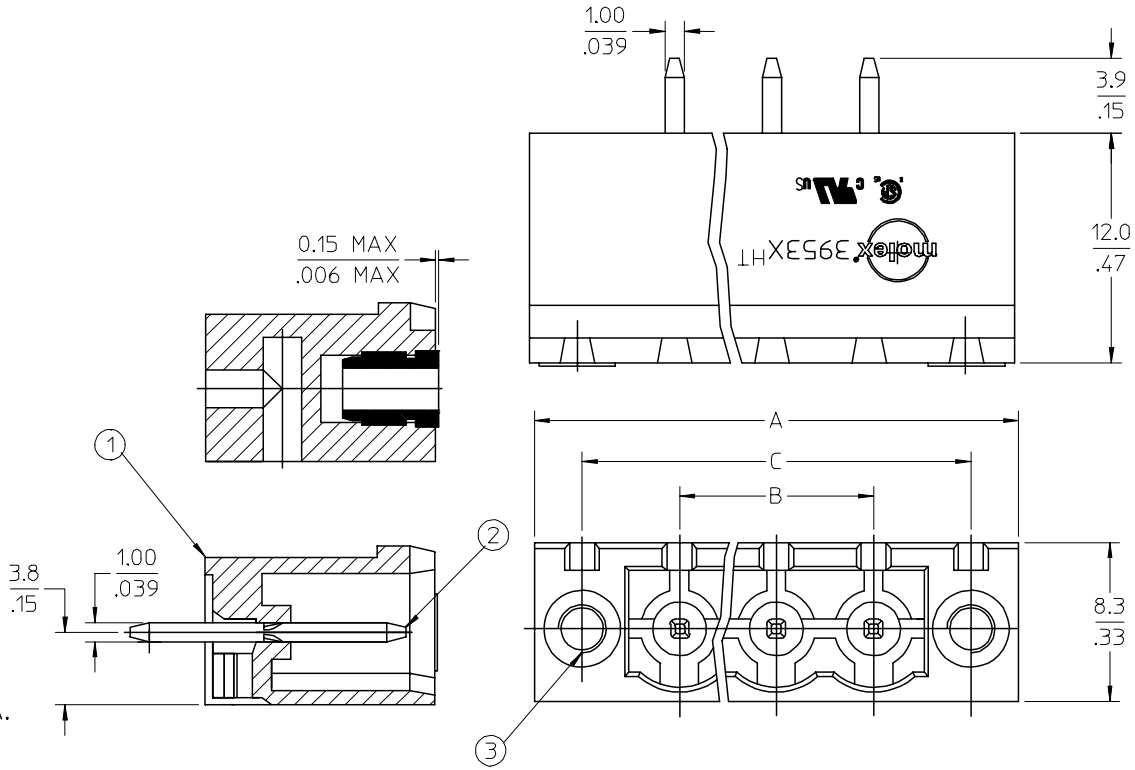

ENTER DESCRIPTION EC NO: NEC2006-0310 DRWNL: LROTHAUS 2006/01/09 CHKD: CYORK 2006/01/09 APPR: JPAMLCK 2006/01/10	QUALITY SYMBOLS ▽=0 ▽=0	GENERAL TOLERANCES (UNLESS SPECIFIED)		DIMENSION STYLE MM/IN		SCALE 4:1	DESIGN UNITS INCH	THIRD ANGLE PROJECTION		
			mm	INCH	DRAWN BY LROTHAUS	DATE 12/6/05	TITLE 5.08MM, EURO HEADER, VERTICAL, HI-TEMP MOUNTING			
		4 PLACES	± ---	± .0015	CHECKED BY C. YORK	DATE 01/06/06				
		3 PLACES	± 0.038	± .005	APPROVED BY		DATE		MOLEX INCORPORATED	
2 PLACES	± 0.13	± .01	MATERIAL NO.		DOCUMENT NO.		SHEET NO.			
1 PLACE	± 0.3	± ---	DRAFT WHERE APPLICABLE MUST REMAIN WITHIN DIMENSIONS		SEE CHART		SD-39535-001		1 OF 1	
		ANGULAR ± 2 °		THIS DRAWING CONTAINS INFORMATION THAT IS PROPRIETARY TO MOLEX INCORPORATED AND SHOULD NOT BE USED WITHOUT WRITTEN PERMISSION						

9 8 7 6 5 4 3 2 1

Description	Circuit size	Material Numbers											Dimensional Information						
		Black						Green					Dim. A Dim. B Dim. C mm inch mm inch mm inch						
		100% Tin			30 u" Gold			100% Tin			30 u" Gold								
		Printing Options			Printing Options			Printing Options			Printing Options								
		None	10AV	11AV	None	10AV	11AV	None	10AV	11AV	None	10AV	11AV						
5.08mm, Euro Header, Vertical, Mounting Ends, High Temp	2	395354002	395354302	395354402	395354502	395354802	395354902	395359002	395359302	395359402	395359502	395359602	395359902	20.32	0.800	5.08	0.200	15.24	0.600
5.08mm, Euro Header, Vertical, Mounting Ends, High Temp	3	395354003	395354303	395354403	395354503	395354803	395354903	395359003	395359303	395359403	395359503	395359603	395359903	25.40	1.000	10.16	0.400	20.32	0.800
5.08mm, Euro Header, Vertical, Mounting Ends, High Temp	4	395354004	395354304	395354404	395354504	395354804	395354904	395359004	395359304	395359404	395359504	395359604	395359904	30.48	1.200	15.24	0.600	25.40	1.000
5.08mm, Euro Header, Vertical, Mounting Ends, High Temp	5	395354005	395354305	395354405	395354505	395354805	395354905	395359005	395359305	395359405	395359505	395359605	395359905	35.56	1.400	20.32	0.800	30.48	1.200
5.08mm, Euro Header, Vertical, Mounting Ends, High Temp	6	395354006	395354306	395354406	395354506	395354806	395354906	395359006	395359306	395359406	395359506	395359606	395359906	40.64	1.600	25.40	1.000	35.56	1.400
5.08mm, Euro Header, Vertical, Mounting Ends, High Temp	7	395354007	395354307	395354407	395354507	395354807	395354907	395359007	395359307	395359407	395359507	395359607	395359907	45.72	1.800	30.48	1.200	40.64	1.600
5.08mm, Euro Header, Vertical, Mounting Ends, High Temp	8	395354008	395354308	395354408	395354508	395354808	395354908	395359008	395359308	395359408	395359508	395359608	395359908	50.80	2.000	35.56	1.400	45.72	1.800
5.08mm, Euro Header, Vertical, Mounting Ends, High Temp	9	395354009	395354309	395354409	395354509	395354809	395354909	395359009	395359309	395359409	395359509	395359609	395359909	55.88	2.200	40.64	1.600	50.80	2.000
5.08mm, Euro Header, Vertical, Mounting Ends, High Temp	10	395354010	395354310	395354410	395354510	395354810	395354910	395359010	395359310	395359410	395359510	395359610	395359910	60.96	2.400	45.72	1.800	55.88	2.200
5.08mm, Euro Header, Vertical, Mounting Ends, High Temp	11	395354011	395354311	395354411	395354511	395354811	395354911	395359011	395359311	395359411	395359511	395359611	395359911	66.04	2.600	50.80	2.000	60.96	2.400
5.08mm, Euro Header, Vertical, Mounting Ends, High Temp	12	395354012	395354312	395354412	395354512	395354812	395354912	395359012	395359312	395359412	395359512	395359612	395359912	71.12	2.800	55.88	2.200	66.04	2.600
5.08mm, Euro Header, Vertical, Mounting Ends, High Temp	13	395354013	395354313	395354413	395354513	395354813	395354913	395359013	395359313	395359413	395359513	395359613	395359913	76.20	3.000	60.96	2.400	71.12	2.800
5.08mm, Euro Header, Vertical, Mounting Ends, High Temp	14	395354014	395354314	395354414	395354514	395354814	395354914	395359014	395359314	395359414	395359514	395359614	395359914	81.28	3.200	66.04	2.600	76.20	3.000
5.08mm, Euro Header, Vertical, Mounting Ends, High Temp	15	395354015	395354315	395354415	395354515	395354815	395354915	395359015	395359315	395359415	395359515	395359615	395359915	86.36	3.400	71.12	2.800	81.28	3.200
5.08mm, Euro Header, Vertical, Mounting Ends, High Temp	16	395354016	395354316	395354416	395354516	395354816	395354916	395359016	395359316	395359416	395359516	395359616	395359916	91.44	3.600	76.20	3.000	86.36	3.400
5.08mm, Euro Header, Vertical, Mounting Ends, High Temp	17	395354017	395354317	395354417	395354517	395354817	395354917	395359017	395359317	395359417	395359517	395359617	395359917	96.52	3.800	81.28	3.200	91.44	3.600
5.08mm, Euro Header, Vertical, Mounting Ends, High Temp	18	395354018	395354318	395354418	395354518	395354818	395354918	395359018	395359318	395359418	395359518	395359618	395359918	101.60	4.000	86.36	3.400	96.52	3.800
5.08mm, Euro Header, Vertical, Mounting Ends, High Temp	19	395354019	395354319	395354419	395354519	395354819	395354919	395359019	395359319	395359419	395359519	395359619	395359919	106.68	4.200	91.44	3.600	101.60	4.000
5.08mm, Euro Header, Vertical, Mounting Ends, High Temp	20	395354020	395354320	395354420	395354520	395354820	395354920	395359020	395359320	395359420	395359520	395359620	395359920	111.76	4.400	96.52	3.800	106.68	4.200
5.08mm, Euro Header, Vertical, Mounting Ends, High Temp	21	395354021	395354321	395354421	395354521	395354821	395354921	395359021	395359321	395359421	395359521	395359621	395359921	116.84	4.600	101.60	4.000	111.76	4.400
5.08mm, Euro Header, Vertical, Mounting Ends, High Temp	22	395354022	395354322	395354422	395354522	395354822	395354922	395359022	395359322	395359422	395359522	395359622	395359922	121.92	4.800	106.68	4.200	116.84	4.600
5.08mm, Euro Header, Vertical, Mounting Ends, High Temp	23	395354023	395354323	395354423	395354523	395354823	395354923	395359023	395359323	395359423	395359523	395359623	395359923	127.00	5.000	111.76	4.400	121.92	4.800
5.08mm, Euro Header, Vertical, Mounting Ends, High Temp	24	395354024	395354324	395354424	395354524	395354824	395354924	395359024	395359324	395359424	395359524	395359624	395359924	132.08	5.200	116.84	4.600	127.00	5.000

SEE SHEET 1 EC NO: NEC2006-0310 DRWNL: LROTHAUS 2006/01/09 CHKDC: CYORK 2006/01/09 APPR: J.P.A.M.L.C.K 2006/01/10	QUALITY SYMBOLS ▽=0 ▽=0	GENERAL TOLERANCES (UNLESS SPECIFIED) mm INCH 4 PLACES ± --- ±.0015 3 PLACES ±0.038 ±.005 2 PLACES ±0.13 ±.01 1 PLACE ±0.3 ± ---	DIMENSION STYLE MM/IN DRAWN BY DATE LROTHAUS 12/16/05 CHECKED BY DATE C. YORK 01/05/06 APPROVED BY DATE	SCALE 4:1 DESIGN UNITS INCH THIRD ANGLE PROJECTION	TITLE 5.08MM, EURO HEADER, VERTICAL, HI-TEMP MOUNTING	
	MATERIAL NO. SEE CHART	DOCUMENT NO. SD-39535-001	SHEET NO. 2 OF 2			
	DRAFT WHERE APPLICABLE MUST REMAIN WITHIN DIMENSIONS			MOLEX INCORPORATED		
	THIS DRAWING CONTAINS INFORMATION THAT IS PROPRIETARY TO MOLEX INCORPORATED AND SHOULD NOT BE USED WITHOUT WRITTEN PERMISSION					